

BR 300 085

ClassicLine safety eye shower with bowl, wall mounted, exposed pipework

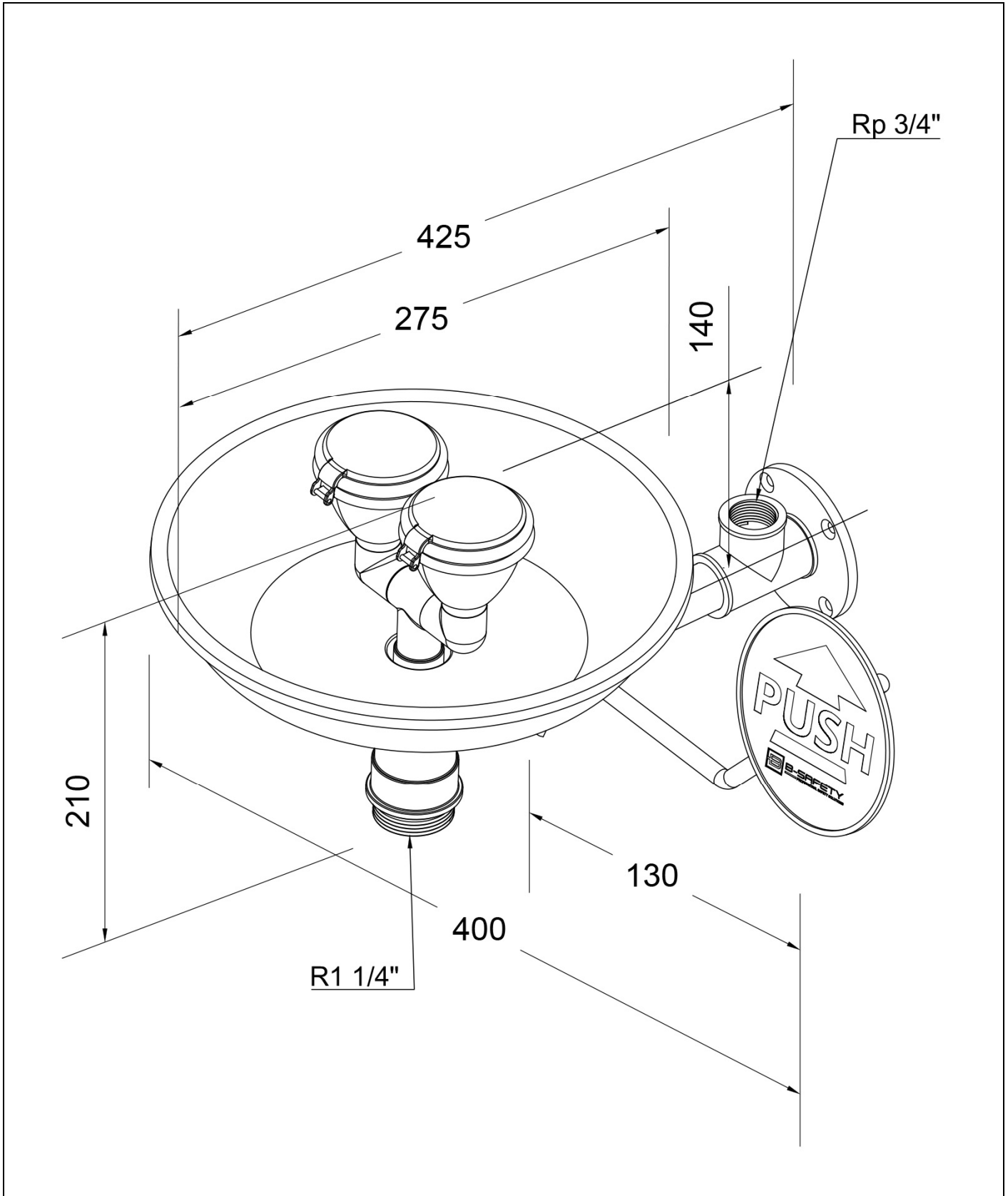

Technical description

ClassicLine safety eye shower with bowl, wall mounted, exposed pipework

- wall flange with 4 mounting holes made of stainless steel, chemical resistant green powder coated, water inlet 3/4" female
- connection pipe of stainless steel for easy installation and alignment of the shower, chemical resistant green powder coated
- ball valve 1/2" of stainless steel, with PUSH-lever actuation, DIN-DVGW tested and certificated
- push plate made of steel, chemical resistant green powder coated, length 240 mm, with large signal "PUSH", luminescent according to DIN 67510
- integrated flow regulation 14 litre / minute for a standard-compliant jet pattern at a specified working range of 2.5 to 5 bar flow pressure
- high-performance spray heads for large-scale dispersion of water, with plastic spray plate, low calcification, incl. rubber sleeves and sealed dust caps, mounted over distributor fork
- bowl made of plastic, green, diameter 275 mm, water outlet 1 1/4" male
- sign for eye shower according to EN ISO 7010 und ASR A1.3, self-adhesive PVC-film, 100 x 100 mm, viewing distance 10 metre
- height 210 mm, projection 425 mm, total width incl. lever 400 mm
- mounting height 860 mm (± 200 mm)
- according to BGI/GUV-I 850-0, DIN 1988 and EN 1717
- according to ANSI Z358.1-2014 and EN 15154-2:2006
- DIN-DVGW tested and certificated

Manufacturer: B-SAFETY or equal
 Article-No.: BR 300 085

Technical specifications

Minimum flow pressure:	2.5 bar
Operating pressure:	2.5 to 5 bar
Flow rate:	14 l/min
Water inlet:	3/4" female
Water outlet:	1 1/4 male
Dimensions (H x W):	210 x 400 mm

Compliance with standards

- EN 15154-2:2006
- ANSI Z358.1-2014

Approvals

- DIN-DVGW, NW-0417CL0263
- GOST-R, Zertifikats-Nr. 0615463

Material overview

Material







Material description

High-performance shower head:	plastic POM, EPDM	-
U-distributor:	plastic POM	-
Ball valve:	stainless steel	AISI 316
Push plate:	steel	-
Flow regulator:	plastic POM	-
Piping, T-pieces, adapter:	stainless steel	AISI 304
Wall flange:	stainless steel	AISI 304
Bowl:	plastic ABS	-
Sign for eye shower:	PVC-foil	-

www.b-safety.com

Product overview	
BR 300 085	ClassicLine safety eye shower with stainless steel bowl, wall mounted, exposed pipework

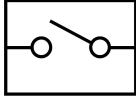
Accessories for safety eye showers

Product overview	Model	Material	Water inlet	Water outlet	Article-No.
	Maintenance ball valve for safety showers with removable trigger lever.	stainless steel	3/4" female	3/4" female	BR 830 955
	Foot lever actuation for eye showers and safety showers, wall mounted. Inclusive fixing material for wall mounting of the spring. Dimension (H x W x D): 50 x 350 x 350 mm	stainless steel	-	-	BR 870 310
	Thermostatic mixing valve for eye showers, adjustment range 20 - 43°C, scald protection 43°C, flow rate max. 20 l/min.	brass	1/2" male and 3/4" male	1/2" male and 3/4" male	BR 710 940
	Flow switch for eye showers and safety showers, protection degree IP 65, electrical supply with 1.5 m cable.	brass	3/4" female	3/4" female	BR 710 800
	Emergency switch for eye showers, complete pre-mounted on shower, for EX-zones 1 & 2.	plastic	-	-	BR 830 450
	Alarm system for eye showers & safety showers with siren-/flashlight combination. Prewired junction box inclusive electronic switch. Electrical supply: 230 V - 50 Hz	-	-	-	BR 015 800