

BR 082 085

ClassicLine body safety shower, wall mounted, exposed pipework

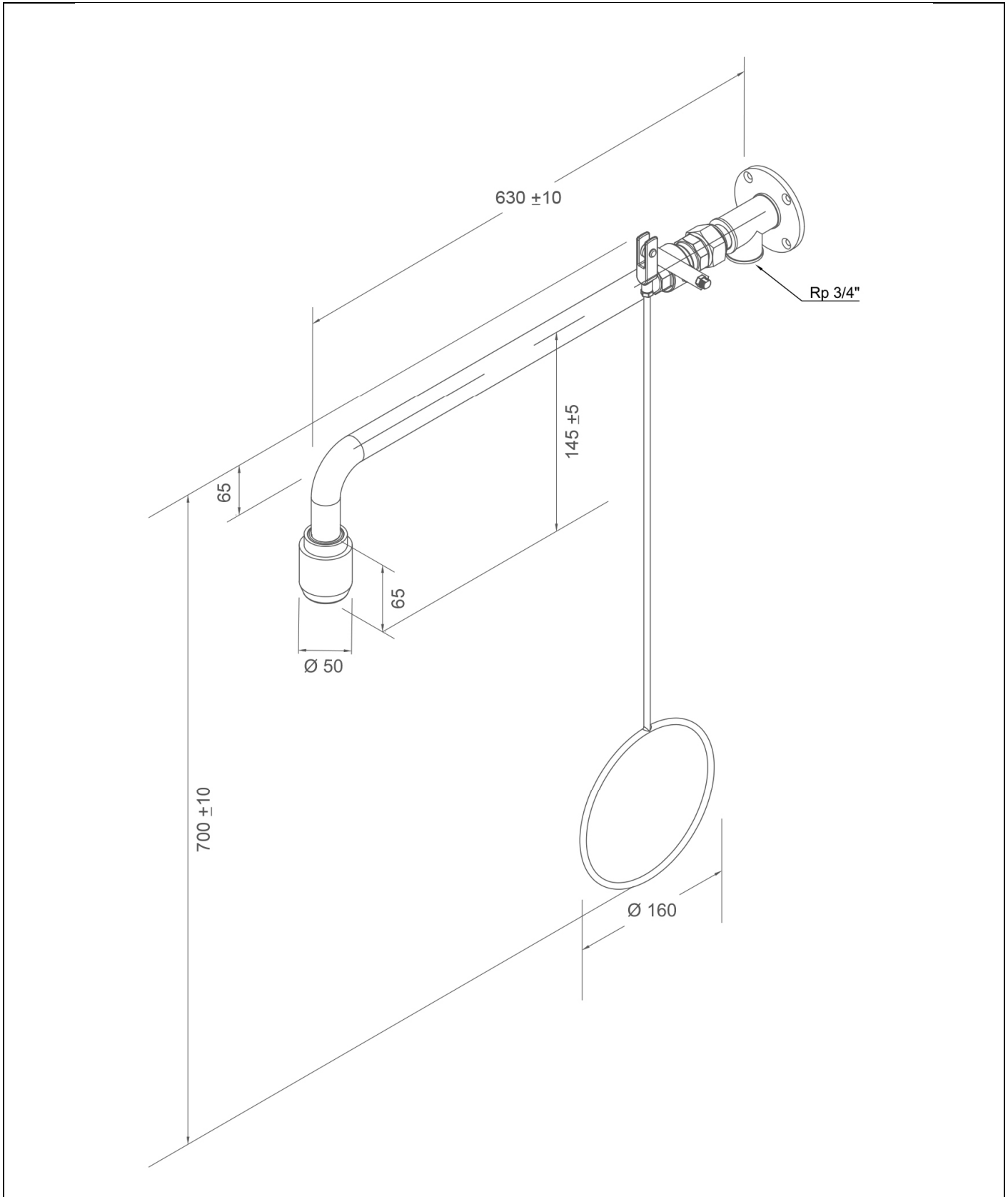

**Technical description**

ClassicLine body safety shower, wall mounted, exposed pipework

- wall flange with 4 mounting holes of stainless steel, chemical resistant green powder coated, water connection 3/4" female
- connection piece made of stainless steel, for quick on-site installation and easy alignment of the shower arm
- ball valve 3/4" made of dezincification-resistant brass, with quick connect system, pull rod actuation, DIN-DVGW tested and certificated
- pull rod with ring handle of stainless steel, chemical resistant green powder coated, length 700 mm
- wall shower arm 3/4" of stainless steel, chemical resistant green powder coated, projection 630 mm
- integrated automatic flow regulator 50 litres / minute for a standard-compliant spray pattern at a specified working range of 1.5 to 3 bar flow pressure
- high-performance shower head of chemical resistant plastics, black, with improved spray pattern, corrosion resistant, largely calcification- and maintenance-free, very robust, self-draining
- sign for body safety shower according to EN ISO 7010 und ASR A1.3, self-adhesive PVC-film, 150 x 150 mm, viewing distance 15 metre
- mounting height 2345 mm (± 100 mm)
- according to BGI/GUV-I 850-0, DIN 1988 and EN 1717
- according to ANSI Z358.1-2014, EN 15154-1:2006 and EN 15154-5:2019
- DIN-DVGW tested and certificated

Manufacturer: B-SAFETY or equal  
 Article-No.: BR 082 085

**Technical specifications**

Minimum flow pressure: 1.5 bar  
 Operating pressure: 1.5 to 3 bar  
 Flow rate: 50 l/min  
 Water inlet: 3/4" female  
 Dimensions (H x W x D): 700 x 86 x 630 mm

**Norm conformity**

- EN 15154-1:2006  
 - EN 15154-5:2019  
 - ANSI Z358.1-2014

**Approvals**

- DIN-DVGW, DVGW, NW-0416CL0425









**Material overview**

Material overview	Material	Material description
High-performance shower head:	plastic POM	-
Ball valve:	Dezincification-resistant, DZR brass	CW724R
Flow regulator:	plastic POM	-
Piping:	stainless steel	AISI 304
Pull rod with ring handle:	stainless steel	AISI 201
Wall flange:	stainless steel	AISI 304
Sign for body safety shower:	PVC-foil	-

[www.b-safety.com](http://www.b-safety.com)

Product overview	
<b>BR 082 085</b>	ClassicLine body safety shower, wall mounted, exposed pipework - flow rate 50 l/min (hazard class I according to EN 15154-5:2019)
<b>BR 082 085 / 75L</b>	ClassicLine body safety shower, wall mounted, exposed pipework - flow rate 75 l/min / 20 GPM (hazard class II according to EN 15154-5:2019)
<b>BR 082 085 / 110L</b>	ClassicLine body safety shower, wall mounted, exposed pipework - flow rate 110 l/min (hazard class III according to EN 15154-5:2019)

**Accessories for body safety showers**

Product overview	Model	Material	Water inlet	Water outlet	Article-No.
	ClassicLine safety sign for safety showers, incl. fasteners for mounting on the shower arm. Dimensions (B x H): 150 x 150 mm	Plastic	-	-	<b>BR 870 150</b>
	ClassicLine cable actuation for injured persons lying on the ground, additional to pull rod.	Stainless steel rope	-	-	<b>BR 082 200</b>
	ClassicLine disability friendly pull rod with double ring handle, green. Length: 1150 mm	Stainless steel	-	-	<b>BR 082 300</b>
	PremiumLine disability friendly pull rod with double ring handle, stainless steel. Length: 1150 mm	Stainless steel	-	-	<b>BR 082 350</b>
	Service shut-off for eye showers and safety showers with removable release lever.	Stainless steel	3/4" female	3/4" female	<b>BR 830 955</b>
	Thermostatic mixing valve for eye showers and safety showers, setting range 20 - 43°C, scald protection 43°C, volume flow approx. 60 l/min at 2 bar flow pressure.	Brass	3/4" male and 1" male	3/4" male and 1" male	<b>BR 710 950</b>
	Flow switch for eye showers, protection degree IP 65, electrical supply with 1.5 m cable.	Brass	3/4" female	3/4" female	<b>BR 710 800</b>
	Switch for body safety shower, complete premounted on shower, for EX-Zones 1 & 2.	Plastic	-	-	<b>BR 830 400</b>
	ClassicLine alarm system for eye showers & safety showers with siren/flashlight combination. Prewired junction box inclusive electronic switch. Electrical supply: 230 V - 50 Hz	Plastic	-	-	<b>BR 015 800</b>